

Discover A New Dimension Of Predictability, Precision, and Affordability

Experience more advanced anatomical views by capturing 3-D images right in your office. Achieve incredibly accurate, immediate assessments with the GXCB-500™, powered by i-CAT®. This breakthrough, Cone Beam 3-D imaging technology is now incorporated into a system featuring ground-breaking affordability.

Enter the diagnostic dimension of predictability and precision, along with affordability. Provide reassurance through considerable radiation reductions, in comparison to traditional CT scans. Build patient confidence in treatment plans with a clear diagnosis backed by visualization. Best of all, this evolution in imaging is easily implemented! The GXCB-500 is a technological plus for patients — and practices.

⇒ Remarkably Fast, Remarkably Accurate

- Rapid 8.9 second scan time
- Full 3-D reconstruction in less than 20 seconds
- Benefit from distortion-free images to reveal critical anatomical details
- Transition quickly from 3-D to 2-D panoramic with a mouse click — no need to switch sensors!

⇒ Targeted Treatments, Surgical Predictability

- 360 degree, 3-D Scans capture oral and maxillofacial features
- **Standard "Jaw" Scan**, 8 cm diameter x 8 cm height: Supports implant planning, endodontics, and surgeries
- **Extended Diameter Scan**, 14 cm diameter x 8 cm height: Assists with TMJ evaluation and airway analysis

⇒ Implementation As Easy As 1-2-3-D

- Comprehensive, on-site training conducted by a certified Gendex 3-D trainer
- i-CATVision™ software included and freely shared
- DICOM 3 compatible images easily exported to third-party applications

Technical Specifications

Gendex GXCB-500™

Focal Spot	0.5 mm
Voxel Sizes	.4, .3, .25, .2, .125 mm
Type of Sensor	Amorphous Silicon Flat Panel
Size of Panel	13 x 13 cm
Line Pairs	14 lp/cm on .2 voxel scan at the object
Grayscale (Bits)	14 bit
Shades of Gray	16384 shades of gray
Field of View	8 cm (d) x 8 cm (h) – Standard Mode 14 cm (d) x 8 cm (h) – EDS Mode
Collimation	Down to 4 cm height
Scan Times	8.9 sec (.3 and .4 voxel, Standard/EDS Mode) 23 sec (.125, .2 and .25 voxel High Resolution Scans)
Reconstruction Times	less than 20 sec – Standard Mode less than 95 sec – EDS Mode
File Sizes	less than 20 MB – Standard Mode less than 76 MB – EDS Mode
Software	Free i-CAT Vision™ viewing and sharing software included
Footprint	48" wide x 46" deep

Unit Dimensions

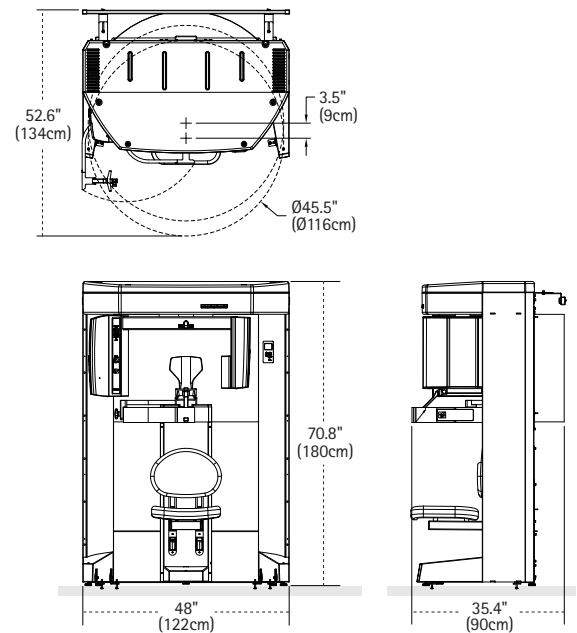

Two Global Imaging Leaders Join Forces

For more than a century, Gendex has been well-known and highly-respected for its reliable and innovative radiographic equipment that improves the clinical lives of both general dentists and specialists worldwide. In 2007, Gendex joined forces with Imaging Sciences International (ISI), creator of the i-CAT® and the recognized leader in Cone Beam 3-D dental imaging. The result of this alliance of Gendex manufacturing history and ISI expertise in 3-D imaging is the GXCB-500, the truly unique Cone Beam system that offers dentists access to the technology they need at an affordable investment.



Gendex Dental Systems
901 West Oakton Street
Des Plaines, IL 60018 U.S.A.
Tel 1-888-275-5286
www.gendex.com

For more information visit:
www.GXCB500.com

The GXCB-500™ is manufactured by Imaging Sciences International for Gendex Dental Systems.

GX CB-500[™]
POWERED BY i-CAT[®]



NEW *from* Gendex!

Enter A New Digital Dimension With
Cone Beam 3-D Imaging From Gendex!

- ☞ Cone Beam 3-D Imaging Systems
- Panoramic X-ray Systems
- Intraoral X-ray Systems
- Digital Intraoral Sensors
- Digital X-ray Phosphor Plates
- Intraoral Cameras
- Imaging Software

GENDEX[®]
Imaging Excellence Since 1893

GX CB-500™

POWERED BY i-CAT®

Designed for the Dental Practice

The GXCB-500 is easy to operate, with simple push-button controls and clear, understandable viewing software

With its compact footprint and overall design, the GXCB-500 integrates easily into the dental office, fitting in the equivalent space of a traditional pan unit

Seated patient positioning and sturdy design minimizes patient movement and captures the natural orientation of anatomy, providing better image quality



Easily switch from Cone Beam 3-D imaging to conventional 2-D panoramic imaging with the click of a mouse — no need to switch sensors!



Remarkably Fast, Remarkably Accurate

The GXCB-500 provides powerful, instantaneous diagnostic and treatment planning tools that surpass the capabilities of conventional 2-D imaging. Now, you can rely on distortion-free images to reveal critical anatomical details.

An Amorphous Silicon Flat Panel Sensor delivers accurate images at a scan time of only 8.9 seconds and yields full, 3-D reconstruction in less than 20 seconds. Remarkably fast image acquisition lets you start treatment planning right away.

This unique single sensor design also allows the GXCB-500 to serve your dental office in dual roles. Be impressed when team members effortlessly switch from Cone Beam 3-D to 2-D imaging. By simply checking a box in the software, the GXCB-500 is transformed into a standard 2-D panoramic unit. You never need to change sensors, so you save precious time.



EDS mode assists in identifying sinus pathology, polyps and other conditions

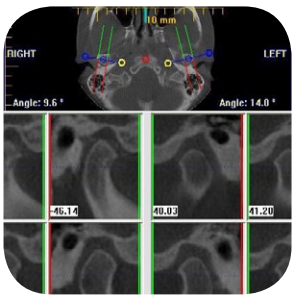

3-D views of the condyles allow clinicians to evaluate the impact of treatment on the joints prior to surgery

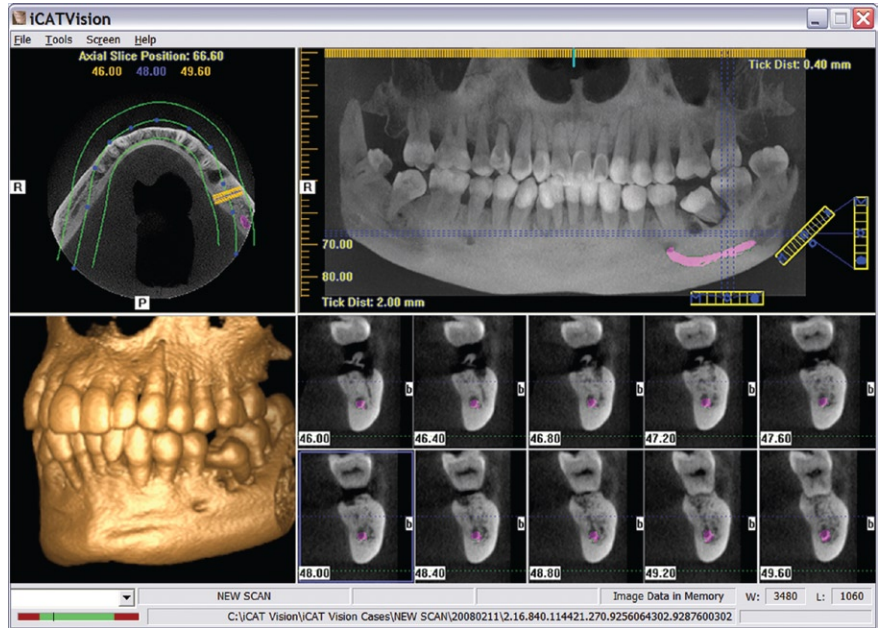

The distinctive Nerve Marking Estimation Tool assists in reducing the risk of undetected nerve canals and in determining exact implant type, size and location prior to surgery.



Standard Scan Mode capture area of 8 cm diameter by 8 cm high

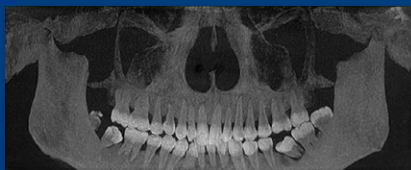

EDS Mode capture area of 14 cm diameter by 8 cm high

Targeted Treatments, Surgical Predictability

Capture anatomically accurate information to assist in diagnosis, planning and treatment. Digitally replicate mouth and jaw anatomy with the exactitude of the GXCB-500. Determine precise tooth positions, bone structure, locations of relative anatomy, and vital structures using complete, 360-degree, three-dimensional scans that display vividly on your computer monitor.

In its Standard Scan mode of 8 cm in diameter by 8 cm in height, the GXCB-500 captures both arches in a single, ultra-speed scan. With this "molar-to-molar" view, images emerge as essential tools for implant planning and surgical planning, as well as endodontics. Cone Beam 3-D imaging generates anatomically correct assessments that support more predictable outcomes in a variety of surgical procedures and implant placements.

But the GXCB-500 doesn't stop here. A unique feature allows you to change from Standard to Extended Diameter Scan (EDS) mode and widen your field of view up to 14 cm in diameter by 8 cm in height. This provides the ability to capture the condyles, for improved TMJ diagnosis and treatment. This Extended Diameter Scan also shares valuable, clear-cut information for airway analysis.

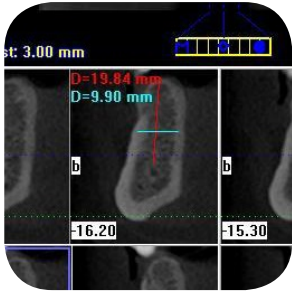

Take accurate measurements of critical anatomies for implant and surgical planning

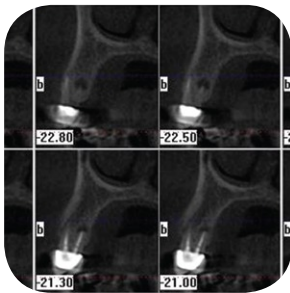

Cross-sectional slices to evaluate roots for endodontic purposes

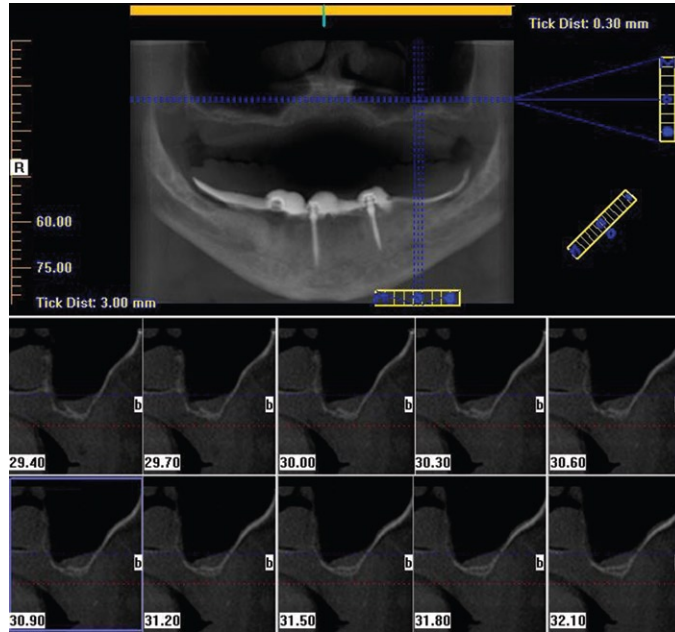

Distortion-free cross-sectional slices of the maxilla and mandible to evaluate quality and volume of bone.



Easy to use i-CATVision software, easy to share compact file sizes

Implementation As Easy As 1-2-3-D

Taking your practice into the next dimension of accurate diagnosis and state-of-the-art treatment planning is easy. Once the GXCB-500 is installed, you and your team experience a full day of in-office training provided by a certified Gendex 3-D trainer. You will receive comprehensive, hands-on instruction covering system and software utilization, leaving no benefit of this remarkable imaging technology uncovered. It's sophistication, simplified.

Not only is the system easy to use, your new 3-D images are easily shared with other clinicians. With compact image file sizes and the freely shared i-CATVision™ software, you'll gain a real 'teamwork' approach to patient care. Adding to the easy 'share-ability', images can also be exported in DICOM 3 compatible format for use in third-party applications.